

Home Automation

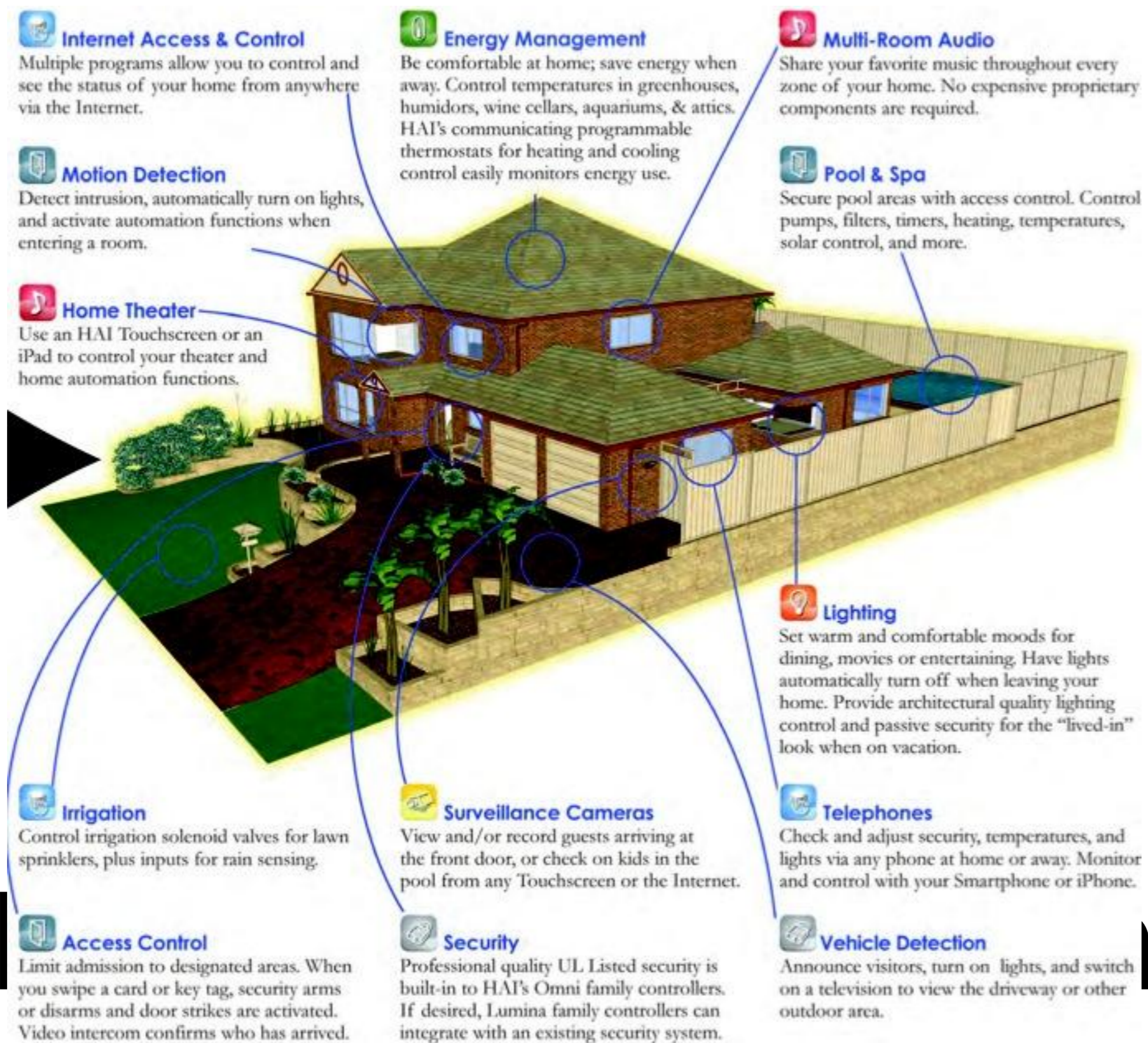

Options

Home Automation Options

- **Internet Access & Control**
- **Motion Detection**
- **Home Theatre**
- **Irrigation**
- **Access Control**
- **Energy Management**
- **Surveillance Cameras**
- **Security**
- **Multi-Room Audio**
- **Pool & Spa**
- **Lighting**
- **Telephones**
- **Vehicle Detection**

INSTEON Home Control



- **SmartLinc (\$130)**
- **RemoteLinc (\$45)**
- **TriggerLinc (\$35)**
- **FanLinc (\$80)**
- **KeypadLinc (\$70)**
- **I/O Linc (\$50)**
- **SwitchLinc Dimmer (\$46)**
- **LampLinc (\$30)**

INSTEON Example

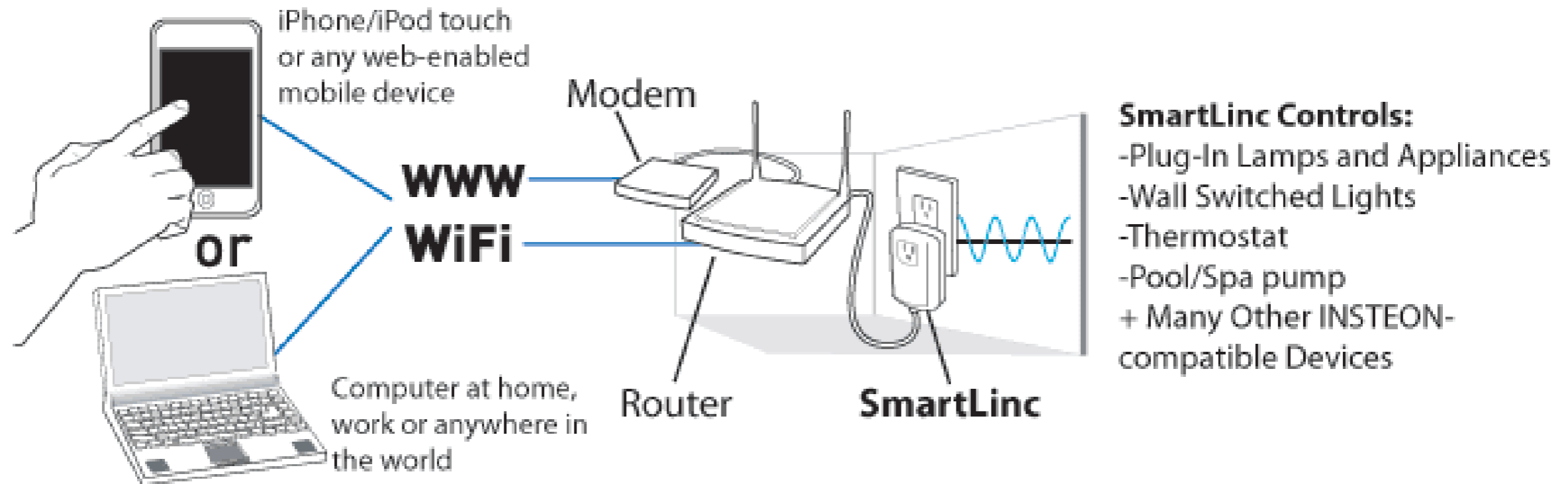

- **iOS, Android App (free)**
- **Central Controller (\$130)**
- **Dimmer Switch (@\$46)**
- **Relay Switch (@\$46)**
- **Thermostat (\$150)**
- **Camera (\$100)**

Popular INSTEON Products



iPod sold separately



What Can INSTEON Control?



⑩ Lighting



Irrigation



•
⑩ HVAC



Security



⑩ A/V



Pool/Spa

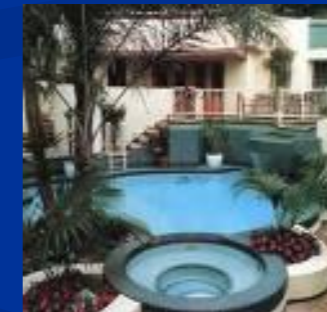

⑩ Blinds



Whole House





**SmartHome Wireless
IP Security Camera
(\$100)**

Compatible w/ iPhone/iPad, Android, Blackberry



Nest Learning Thermostat

(\$250)



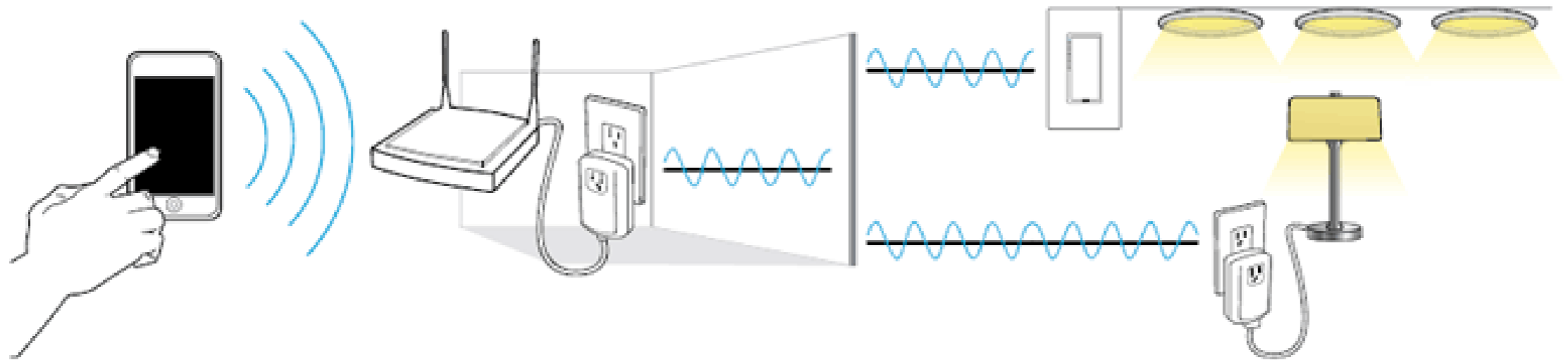

Control Lights w/ iPhone

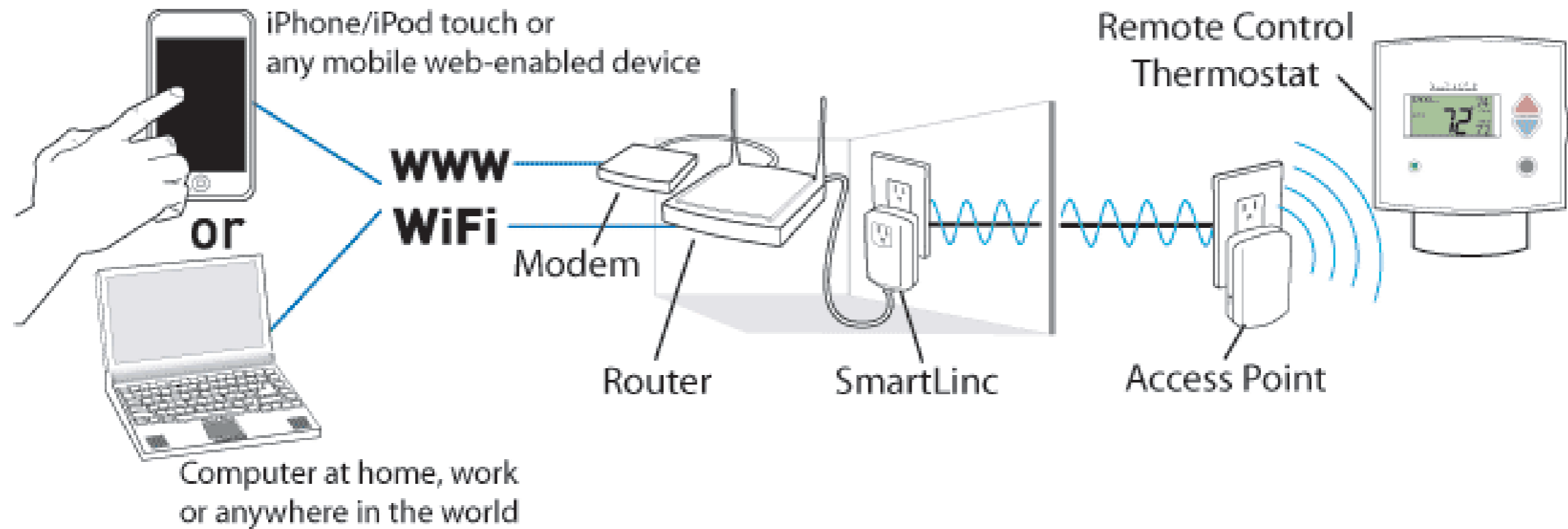

Control Thermostat Remotely

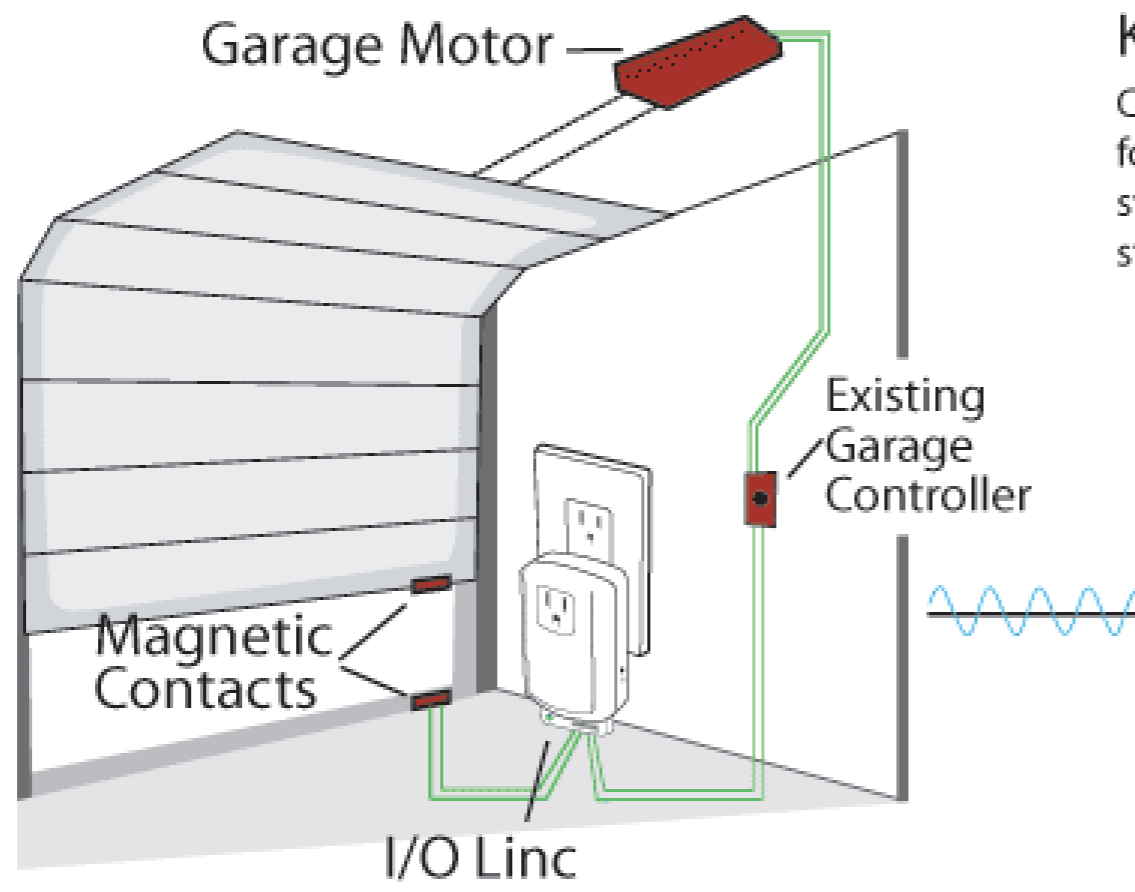

KeypadLinc

Change out a switch in your bedroom or entryway for this keypad and it will still control what your old switch controlled but you'll also be able to read status and control devices throughout your home.

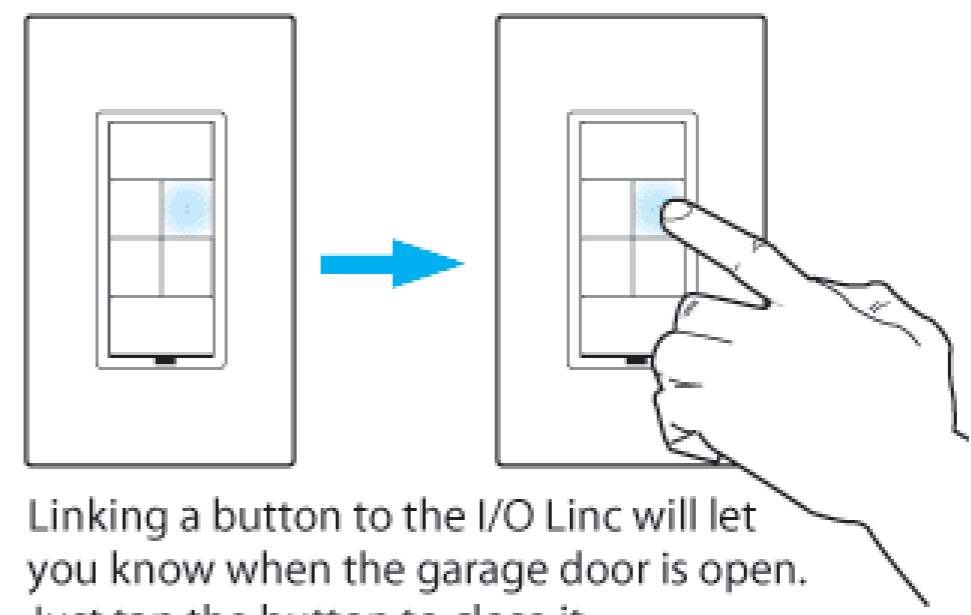

Linking a button to the I/O Linc will let you know when the garage door is open. Just tap the button to close it.

Door Monitor/Controller

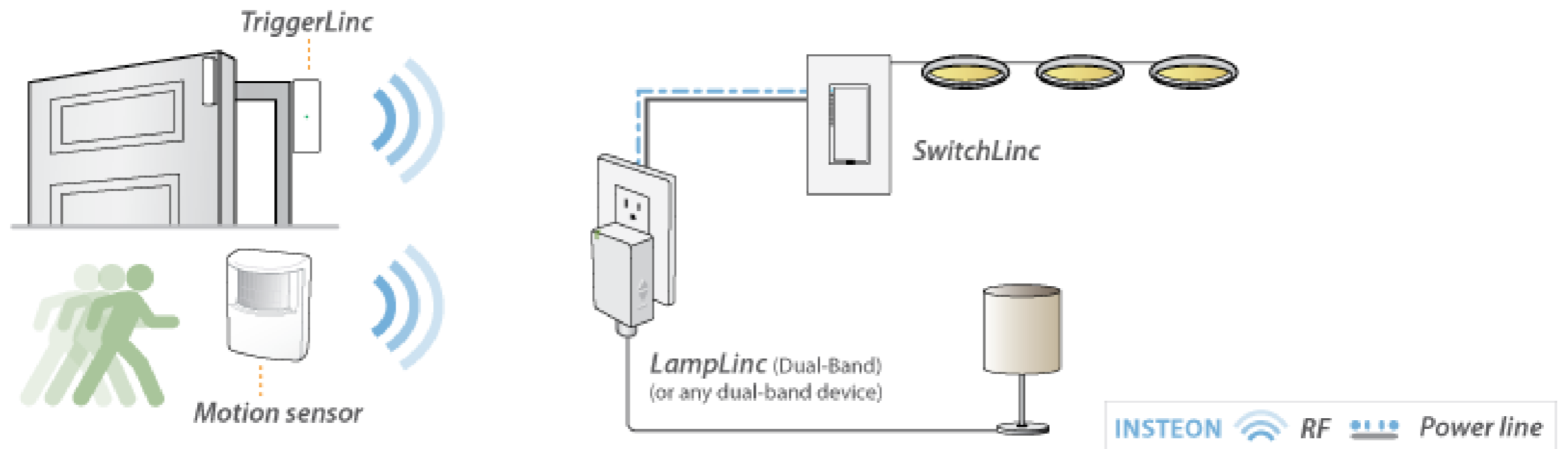

Motion Activated Lighting Control

A good source of
Home Automation
products check-out:
www.smarthome.com